

# SDM630MCT(-2T)

*Smart Three Phase Energy Meter*



**USER MANUAL**  
**2026 V1.2**

## Statements

All rights reserved. Without the written permission of the company, no paragraphs or chapters in this manual can be extracted, copied or reproduced in any form. Otherwise, the violator shall bear all consequences.

Eastron reserves all legal rights.

Eastron reserves the right to amend the product specifications in this manual without prior notice. Before placing an order, please contact our company or local agent to get the latest specifications.

# CONTENT

<b>Version History</b> .....	<b>1</b>
<b>Risk Information</b> .....	<b>2</b>
<b>Chapter 1. Introduction</b> .....	<b>4</b>
1.1 Product Introduction .....	4
1.2 Product Characteristics .....	4
<b>Chapter 2. Technical Parameters</b> .....	<b>5</b>
2.1 Technical Parameters .....	5
2.2 Mechanical Characteristics .....	5
2.3 Performance Criteria .....	5
2.4 Electromagnetic Compatibility .....	5
2.4 Safety .....	6
2.5 Accuracy .....	6
2.6 Communication .....	6
2.7 Dimensions .....	6
2.8 Wiring Diagram .....	7
<b>Chapter 3. Operation</b> .....	<b>9</b>
3.1 Installation Display .....	9
3.2 Button Functions .....	9
3.3 Measurements .....	10
3.4 Auxiliary Mode .....	15
3.5 Setup Mode .....	15
<b>Chapter 4. Declaration of Conformity ( For MID meter only)</b> .....	<b>18</b>
<b>Chapter 5. Communication Protocol</b> .....	<b>19</b>
5.1 Input Register .....	19
5.2 Holding Register .....	22

# Version History

Version	Date	Changes
1.0	2025-2-28	Initial issue
1.1	2026-3-20	Change CT range
1.2	2026-4-2	PT wiring method added

## Risk Information

### Information for Your Own Safety

This manual does not contain all of the safety measures operating the equipment (module, device) for different conditions and requirements. However, it does contain information which you must know for your own safety and to avoid damages. These information are highlighted by a warning triangle indicating the degree of potential danger.



#### Warning

This means that failure to observe the instruction can result in death, serious injury or considerable material damage.



#### Caution

This means hazard of electric shock and failure to take the necessary safety precautions will result in death, serious injury or considerable material damage.

### Qualified personnel

Operation of the equipment (module, device) described in this manual may only be performed by qualified personnel. Qualified personnel in this manual means person who are authorized to commission, start up, ground and label devices, systems and circuits according to safety and Regulatory standards.

### Proper handling

The prerequisites for perfect, reliable operation of the product are proper transport, proper storage, installation and proper operation and maintenance. When operating electrical equipment, parts of this equipment automatically carry dangerous voltages. Improper handling can therefore result in serious injuries or material damage.

- ✧ Use only insulating tools.
- ✧ Do not connect while circuit is live (hot).
- ✧ Place the meter only in dry surroundings.
- ✧ Do not mount the meter in an explosive area or expose the meter to dust, mildew and insects.
- ✧ Make sure the wires are suitable for the maximum current of this meter.
- ✧ Make sure the AC wires are connected correctly before activating the current/voltage to the meter.
- ✧ Do not touch the meter connecting clamps directly with metal, blank wire and your bare hands as you may get electrical shock.
- ✧ Make sure the protection cover is placed after installation.
- ✧ Installation, maintenance and reparation should only be done by qualified personnel.
- ✧ Never break the seals and open the front cover as this might influence the function of the meter, and will cause no warranty.
- ✧ Do not drop, or allow strong physical impact on the meter as the high precisely components inside may be damaged.
- ✧ Designed to be mounted inside of switchboards or cabinet on DIN rail.

- ✧ This device must have a suitable sized Circuit Breaker feeding the Multi Function Energy Meter so it does not exceed the maximum rated current.
- ✧ The supply wiring of this device shall be suitable sized cable to match the installed circuit breaker.
- ✧ A Disconnection Device (Circuit Breaker) should be installed close to the Multi Function Energy Meter.
- ✧ The Disconnection Device shall be marked as the Disconnection Device for the Multi Function Energy Meter.

**Disclaimer**

We have checked the contents of this publication and every effort has been made to ensure that the descriptions are as accurate as possible.

However, deviations from the description cannot be completely ruled out, so that no liability can be accepted for any errors contained in the information given. The data in this manual is checked regularly and the necessary corrections are included in subsequent editions. We are grateful for any improvements that you suggest.

## Chapter 1. Introduction

### 1.1 Product Introduction

SDM630MCT and SDM630MCT-2T are Eastron's new-generation three-phase smart energy meters. The meter measures and displays the characteristics of single phase two wire (1p2w), three phase three wire (3p3w) and three phase four wire (3p4w) supplies, including voltage, frequency, current, power, active and reactive energy, imported or exported. Energy is measured in terms of kWh, kVAh. Maximum demand current can be measured over preset periods of up to 60 minutes. In order to measure energy, the unit requires voltage and current inputs in addition to the supply required to power the product. The requisite current input(s) are obtained via current transformers(CT).

The meter can be configured to work with a wide range of CTs with 1A/5A output, giving the unit a wide range of operation. An RS485 communication port is available on the meter for remote data transmission. SDM630MCT-2T also offers a 2 tariff port for dual power source metering.

This unit can be powered from a separate auxiliary AC power supply. Alternatively it can be powered from the monitored supply, where appropriate.

### 1.2 Product Characteristics

- Bi-directional measurement IMP & EXP
- RS485 Modbus RTU
- Multi-parameters measurement
- LCD with white backlit, adjustable backlit time

#### Measurements:

- Phase voltage: V1, V2, V3
- Line voltage: V1-2, V2-3, V3-1
- Current: I1, I2, I3, IN
- Active power: P1, P2, P3, P\_total (total active power)
- Reactive power: Q1, Q2, Q3, Q\_total (total reactive power)
- Apparent power: S1, S2, S3, S\_Total (total apparent power)
- Frequency: Hz
- Power factor: PF
- Active energy: Ep\_imp (import active energy), Ep\_exp (export active energy), Ep\_total (total active energy)
- Reactive energy: Eq\_imp (import reactive energy), Eq\_exp (export reactive energy), Eq\_total (total reactive energy)
- THD-I and THD-U
- Maximum demand: MD

#### Setup:

- RS485 Modbus RTU
- Demand interval time
- Backlit time
- Supply system 1p2w, 3p3w, 3p4w
- Reset
- Password modification

## Chapter 2. Technical Parameters

### 2.1 Technical Parameters

Voltage AC (Un)	3*230/400VAC
Voltage range	100 - 277V AC( L-N )
Voltage between phase	100 to 480V AC ( L-L)
Current input	0.05-5(6)A
Over current withstand	20Imax for 0.5S
Frequency rating value	50/60Hz
AC voltage withstand	4KV/1min
Impulse voltage withstand	6kV – 1.2/50μS waveform
Power consumption	≤ 2W/10VA
Display	LCD with white backlit
Max. reading	9999999.9 kWh/kVArh

### 2.2 Mechanical Characteristics

Weight	≈310g
IP Degree of Protection (IEC 60529)	IP51 Front Display IP20 Whole Meter
Dimensions (DxHxW)	65*94.5*72mm
Mounting	DIN Rail 35mm
Material of Meter Case	Self-extinguishing UL 94 V-0
Mechanical Environment	M1

### 2.3 Performance Criteria

Operation humidity	≤90% Non-condensing
Storage humidity	≤95% Non-condensing
Operating temperature	-40°C~+70°C
Storage temperature	-40°C~+80°C
Pollution Degree	2
Altitude	≤2000m
Vibration	10Hz to 50Hz, IEC 60068-2-6

### 2.4 Electromagnetic Compatibility

Electrostatic Discharge	IEC 61000-4-2
Immunity to Radiated Fields	IEC 61000-4-3
Immunity to Fast Transients	IEC 61000-4-4
Immunity to Impulse Waves	IEC 61000-4-5
Conducted Immunity	IEC 61000-4-6
Immunity to Magnetic Fields	IEC 61000-4-8
Immunity to Voltage Dips	IEC 61000-4-11
Radiated Emissions	EN55032 Class B
Conducted Emissions	EN55032 Class B

## 2.4 Safety

Over-voltage Category	CAT III
Installation Category	CAT III
Current Inputs	Require External Current Transformer for Insulation
Insulating Encased Meter of Protective Class	II

## 2.5 Accuracy

Parameters	Accuracy	Resolution
Voltage	±0.5%	0.1V
Current	±0.5%	0.1A
Frequency	±0.2%	0.01Hz
Power Factor	±1%	0.001
Active Power	±1%	0.01kW
Reactive Power	±1%	0.01kVAr
Apparent Power	±1%	0.01kVA
Active Energy	Class 0.5S IEC62053-22 Class C EN50470-3:2022	0.1kWh
Reactive Energy	Class 2 IEC 62053-23	0.1kVArh

## 2.6 Communication

### RS485 Modbus RTU

For Modbus RTU, the following RS485 communication parameters can be configured from the Set-up menu:

Bus Type	RS485
Communication Protocol	Modbus RTU
Baud Rate	2.4k/4.8k/9.6k(default)/19.2k /38.4k bps
Address Range	001 to 247
Bus Load	64 PCS
Communication Distance	1000m
Parity Bit	none(default)/ odd / even
Stop Bit	1 or 2
Data Bits	8

## 2.7 Dimensions

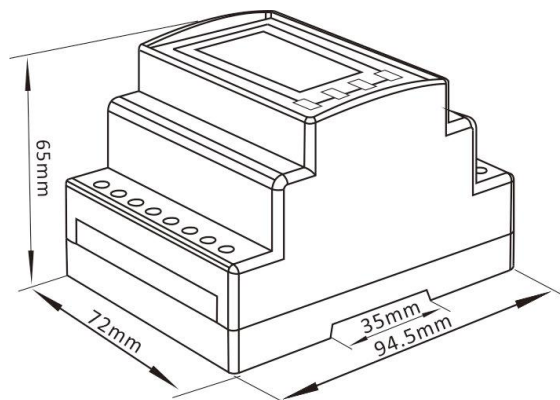

Height: 94.5 mm  
Width: 72mm  
Depth: 65mm

## 2.8 Wiring Diagram

### Current and Voltage Inputs

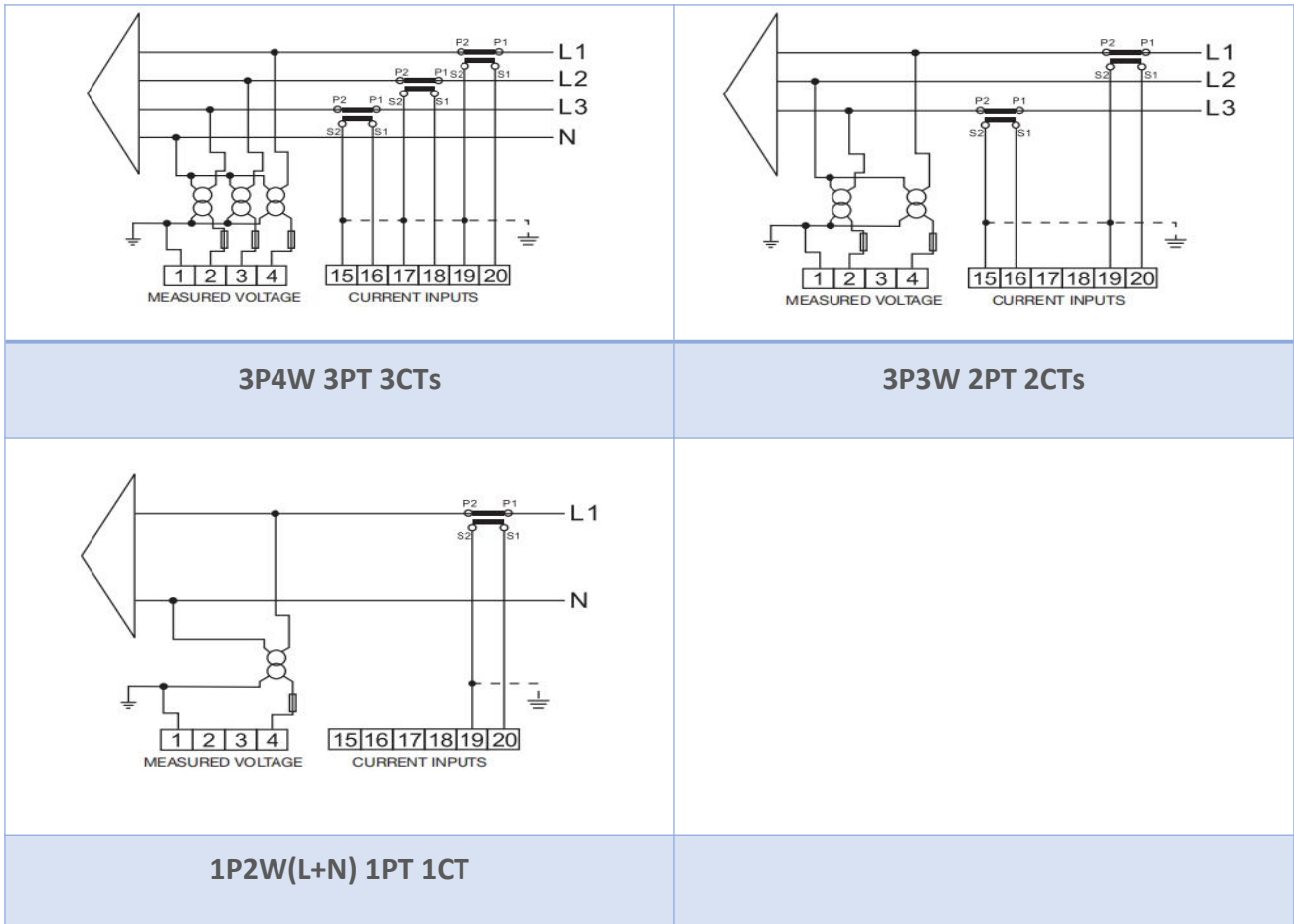

### Definitions of Other Terminals

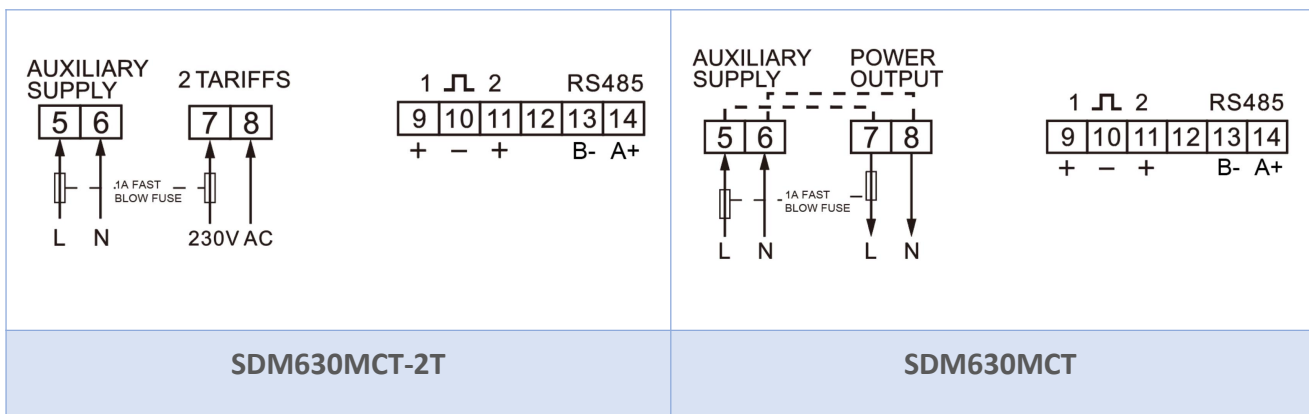

### Wiring Guide

Terminal ①~⑧	Measurement Connection	Screw Connection
	Strip Length	6-7mm
	Rigid/Supple	0.5-2.5mm <sup>2</sup> (22~12 AWG)
	Tightening Torque	0.4Nm
	Model	PH0
Terminal ⑨~⑳	Measurement Connection	Screw Connection
	Strip Length	6-7mm
	Rigid/Supple	0.5-2.5mm <sup>2</sup> (30~12 AWG)
	Tightening Torque	0.4Nm
	Model	PH0

## Installation

Step 1: Select a 35mm-wide DIN rail, Pull down the back-end clip on the meter to unlock the mounting mechanism.

Step 2: Align Upper Slot with DIN Rail. Position the upper slot of the meter's DIN rail groove onto the DIN rail, ensuring full contact (see Figure 1).



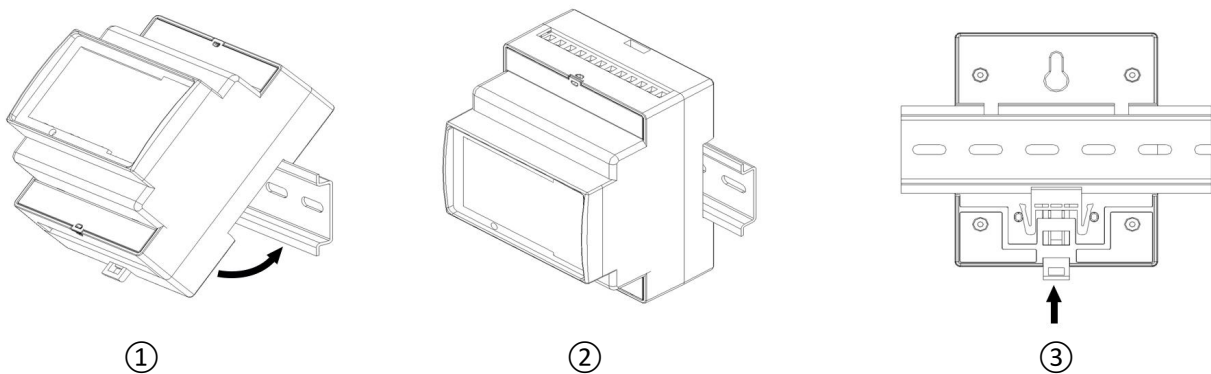

Step 3: Following the direction indicated in Figure 1, engage the lower slot of the DIN rail groove onto the DIN rail until audibly seated (see Figure 2).

Step 4: Push up the back-end clip to lock the meter firmly onto the DIN rail (see Figure 3).





## Chapter 3. Operation

### 3.1 Installation Display

	<p>The first screen lights up all display segments and can be used as a display check.</p>
	<p>The second screen and the third screen indicates the firmware installed in the unit.</p>
	<p>Note: the actual display might be different with the left on here.</p>
	<p>The interface performs a self-test and indicates the result if the test passes.</p>

### 3.2 Button Functions

Button	Short click		Long press (3s)	
	Display mode	Setup mode	Display mode	Setup mode
	V1 V2 V3 V1-2 V2-3 V3-1 I1 I2 I3 IN V %THD I %THD	Return to previous menu		
	Hz PF PF1 PF2 PF3 MD of I1 I2 I3 MD of Power	Previous page or increase value	CRC	

	P1 P2 P3 Q1 Q2 Q3 S1 S2 S3 P-t Q-t S-t	Next page or decrease value		
	Active E-t Reactive E-t Imp Active E Exp Active E Imp Reactive E Exp Reactive E	Move to right side	Enter Setup mode	Confirm setting
<p>Note: For tariff meters, the display is different. Please refer to the following content for detailed information.</p>				

### 3.3 Measurements

#### 3.3.1 Voltage and current

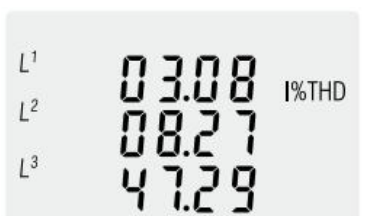

Each successive pressing of the button selects a new range:

	Phase to neutral voltage (Not available under 3P3W)
	Phase to phase voltage (Not available under 1P2W)
	Current of each phase
	Neutral current (Not available under 3P3W & 1P2W)

	Phase to neutral voltage THD% (Phase to phase voltage THD% under 3P3W)
	Phase current THD%



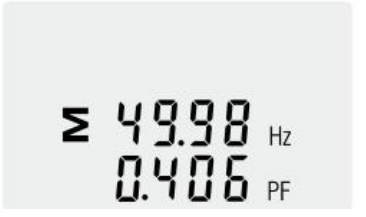
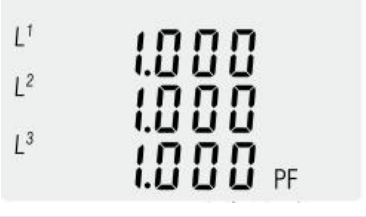

### 3.3.2 Frequency, Power factor and Demand

Each successive pressing of the  button selects a new range:

	Frequency and Power Factor (total)
	Power Factor of each phase (Not available under 3P3W & 1P2W)
	Maximum current demand of each phase
	Maximum total power demand

### 3.3.3 Power

Each successive pressing of the  button select a new range:





	Instantaneous Active Power in kW (Not available under 3P3W & 1P2W)
	Instantaneous Reactive Power in kVAr (Not available under 3P3W & 1P2W)
	Instantaneous Volt-amps in kVA (Not available under 3P3W & 1P2W)
	Total W, VAr, VA

### 3.3.4 Energy

Each successive pressing of the  button shows following measurements:

For SDM630MCT:

	Total active energy in kWh
---	----------------------------

	Total reactive energy in kVArh
	Imported active energy in kWh
	Exported active energy in kWh
	Imported reactive energy in kVArh
	Exported reactive energy in kVArh

For SDM630MCT-2T:

	Total active energy in kWh
---	----------------------------

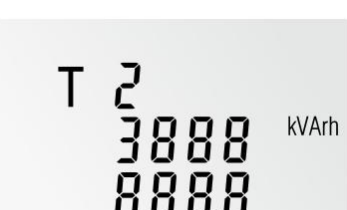
	Total reactive energy in kVArh
	T1 active energy in kWh (Run means under T1 calculation )
	T2 active energy in kWh
	T1 reactive energy in kVArh (Run means under T1 calculation )
	T2 reactive energy in kVArh

\*SDM630MCT-2T show tariff kWh/kVArh instead of imported and exported kWh/kVArh

### 3.4 Auxiliary Mode



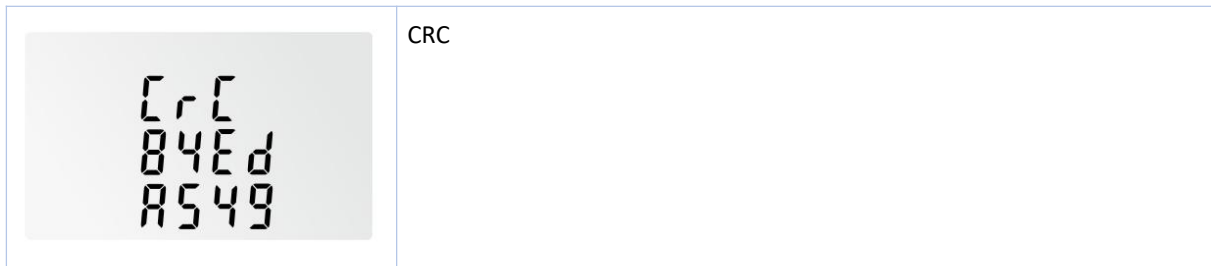







Each successive Long pressing of the  button enter the auxiliary:



### 3.5 Setup Mode

The meter's settable parameters are password protected. Each successive Long pressing on the  button to enter setup mode. Some menu items, such as password and CT, require a four-digit number entry while others, such as supply system, require selection from a number of menu options.





#### 3.5.1 Menu Option Selection

1. Use the  and  buttons to scroll through the different options of the set up menu.
  2. Long press  to confirm your selection.
  3. If an item flashes, then it can be adjusted by the  and  buttons.
  4. Having selected an option from the current layer, long press  to confirm your selection.
  5. Having completed a parameter setting, press  to return to a higher menu level.
- You will be able to use the  and  buttons for further menu selection.
6. On completion of all setting-up, press  repeatedly until the measurement screen is restored.









#### 3.5.2 Number Entry Procedure

When setting up the unit, some screens require the entering of a number. In particular, on entry to the setting up section, a password must be entered. Digits are set individually, from left to right.

The procedure is as follows:

1. The current digit to be set flashes and is set using the  and  buttons.
2. Short press  to confirm the digit setting and remove to the next.
3. After setting the last digit, long press  to confirm the setting.
4. Press  to return to a higher menu level.

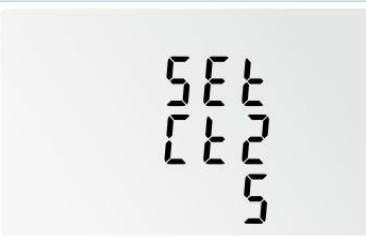
Settings interface	Set status	Optional configuration
--------------------	------------	------------------------

		<b>Password</b> Default: 1000
		<b>ModBus address setting</b> Address range: 001~247 Default: 001
		<b>Baud rate setting</b> Option: 2.4k, 4.8k, 9.6k, 19.2k, 38.4k bps Default: 9.6k bps
		<b>Parity bit setting</b> Option: EVEN, ODD, NONE Default: NONE
		<b>Stop bit setting</b> Option: 1, 2 Default: 1
		<b>CT2 setting</b> Option: 1, 5A Default: 5A
		<b>CT rate setting</b> Rang: 1. 0001~9999(CT2 = 1) 2. 0001~9999(CT2 = 5) Default: 0005

		<b>PT2 setting</b> Rang: 100~500V Default: 400V
		<b>PT rate setting</b> Rang: 0001~2000 Default: 0001
		<b>Pulse output setting</b> Option: kWh, kVArh Default: kVArh
		<b>Pulse rate setting</b> Option: 0.01, 0.1, 1, 10, 100, 1000 kWh/kVArh per imp Default: 0.01 kWh/kVArh per imp
		<b>Pulse duration setting</b> Option: 200, 100, 60 mS Default: 200mS
		<b>Demand interval time setting</b> Option: 0, 5, 8, 10, 15, 20, 30, 60min Default: 60min
		<b>Backlit time setting</b> Option: 0, 5, 10, 30, 60, 120 min Default: 0  *0 means always on

		<b>System type setting</b> Option: 3P4W, 3P3W, 1P2W Default: 3P4W
		<b>CLR max demand setting</b>
		<b>Password setting</b> Range: 0000~9999 Default: 1000
		<b>IA current direction setting</b> Option: Frd, Rev Default: Frd  *Frd = Forward; Rev = Reverse *And so on for IB & IC operation.

## Chapter 4. Declaration of Conformity ( For MID meter only)

We, Zhejiang Eastron Electronic Co., Ltd. declares under our sole responsibility as the manufacturer that the three phase multi-function electrical energy meter SDM630MCT(-2T) correspond to the production model described in the EU-type examination certificate and the requirements of the Directive 2014/32/EU.

Type examination certificate number 0120/SGS0703.

Identification number of the Notified Body: 0598.

## Chapter 5. Communication Protocol

### 5.1 Input Register

Function code	Description
04	Read Input Register

Address (Register)	Input Register Parameter				Modbus Protocol Start Address Hex		3 Ø	3 Ø	1 Ø
	Description	Length (bytes)	Data Format	Units	Hi Byte	Lo Byte	4 W	3 W	2 W
30001	L1 line to neutral RMS volts	4	Float	V	00	00	✓	X	✓
30003	L2 line to neutral RMS volts	4	Float	V	00	02	✓	X	X
30005	L3 line to neutral RMS volts	4	Float	V	00	04	✓	X	X
30007	L1 RMS current	4	Float	A	00	06	✓	✓	✓
30009	L2 RMS current	4	Float	A	00	08	✓	✓	X
30011	L3 RMS current	4	Float	A	00	0A	✓	✓	X
30013	L1 active power	4	Float	W	00	0C	✓	X	✓
30015	L2 active power	4	Float	W	00	0E	✓	X	X
30017	L3 active power	4	Float	W	00	10	✓	X	X
30019	L1 apparent power	4	Float	VA	00	12	✓	X	✓
30021	L2 apparent power	4	Float	VA	00	14	✓	X	X
30023	L3 apparent power	4	Float	VA	00	16	✓	X	X
30025	L1 reactive power	4	Float	VAr	00	18	✓	X	✓
30027	L2 reactive power	4	Float	VAr	00	1A	✓	X	X
30029	L3 reactive power	4	Float	VAr	00	1C	✓	X	X
30031	L1 power factor <sup>(1)</sup>	4	Float	None	00	1E	✓	X	✓
30033	L2 power factor <sup>(1)</sup>	4	Float	None	00	20	✓	X	X
30035	L3 power factor <sup>(1)</sup>	4	Float	None	00	22	✓	X	X
30037	L1 phase angle	4	Float	Degrees	00	24	✓	X	✓
30039	L2 phase angle	4	Float	Degrees	00	26	✓	X	X
30041	L3 phase angle	4	Float	Degrees	00	28	✓	X	X
30043	Average line to neutral RMS volts	4	Float	V	00	2A	✓	X	X

30047	Average line RMS current	4	Float	A	00	2E	✓	✓	✓
30049	Sum of line RMS currents	4	Float	A	00	30	✓	✓	✓
30053	Total active power	4	Float	W	00	34	✓	✓	✓
30057	Total apparent power	4	Float	VA	00	38	✓	✓	✓
30061	Total reactive power	4	Float	VAr	00	3C	✓	✓	✓
30063	Total power factor <sup>(1)</sup>	4	Float	None	00	3E	✓	✓	✓
30071	Frequency	4	Float	Hz	00	46	✓	✓	✓
30073	Import active energy	4	Float	kWh	00	48	✓	✓	✓
30075	Export active energy	4	Float	kWH	00	4A	✓	✓	✓
30077	Import reactive energy	4	Float	kVArh	00	4C	✓	✓	✓
30079	Export reactive energy	4	Float	kVArh	00	4E	✓	✓	✓
30081	Apparent energy	4	Float	kVAh	00	50	✓	✓	✓
30083	Ah	4	Float	Ah	00	52	✓	✓	✓
30085	Total active power demand <sup>(2)</sup>	4	Float	W	00	54	✓	✓	✓
30087	Max. total active power demand <sup>(2)</sup>	4	Float	W	00	56	✓	✓	✓
30101	Apparent power demand	4	Float	VA	00	64	✓	✓	✓
30103	Apparent power max. demand	4	Float	VA	00	66	✓	✓	✓
30105	Neutral current demand	4	Float	Amps	00	68	✓	X	X
30107	Max. neutral current demand	4	Float	Amps	00	6A	✓	X	X
30109	Reactive power demand <sup>(2)</sup>	4	Float	VAr	00	6C	✓	✓	✓
30111	Reactive power max. demand <sup>(2)</sup>	4	Float	VAr	00	6E	✓	✓	✓
30201	L1 to L2 volts	4	Float	V	00	C8	✓	✓	X
30203	L2 to L3 volts	4	Float	V	00	CA	✓	✓	X
30205	L3 to L1 volts	4	Float	V	00	CC	✓	✓	X
30207	Average line to line volts	4	Float	V	00	CE	✓	✓	X
30225	Neutral current	4	Float	A	00	E0	✓	X	X
30235	L1 L/N volts THD	4	Float	%	00	EA	✓	X	✓
30237	L2 L/N volts THD	4	Float	%	00	EC	✓	X	X
30239	L3 L/N volts THD	4	Float	%	00	EE	✓	X	X
30241	L1 Current THD	4	Float	%	00	F0	✓	✓	✓
30243	L2 Current THD	4	Float	%	00	F2	✓	X	X

30245	L3 Current THD	4	Float	%	00	F4	✓	✓	X
30249	Average line to neutral volts THD	4	Float	%	00	F8	✓	X	✓
30251	Average line current THD	4	Float	%	00	FA	✓	✓	✓
30259	L1 current demand	4	Float	A	01	02	✓	✓	✓
30261	L2 current demand	4	Float	A	01	04	✓	✓	X
30263	L3 current demand	4	Float	A	01	06	✓	✓	X
30265	Maximum L1 current demand	4	Float	A	01	08	✓	✓	✓
30267	Maximum L2 current demand	4	Float	A	01	0A	✓	✓	X
30269	Maximum L3 current demand	4	Float	A	01	0C	✓	✓	X
30335	L1 to L2 volts THD	4	Float	%	01	4E	X	✓	X
30337	L2 to L3 volts THD	4	Float	%	01	50	X	✓	X
30339	L3 to L1 volts THD	4	Float	%	01	52	X	X	X
30341	Average line to line volts THD	4	Float	%	01	54	X	✓	X
30343	Total kWh <sup>(3)</sup>	4	Float	kWh	01	56	✓	✓	✓
30345	Total kVarh <sup>(3)</sup>	4	Float	kVarh	01	58	✓	✓	✓
30347	L1 import kWh	4	Float	kWh	01	5A	✓	X	✓
30349	L2 import kWh	4	Float	kWh	01	5C	✓	X	X
30351	L3 import kWh	4	Float	kWh	01	5E	✓	X	X
30353	L1 export kWh	4	Float	kWh	01	60	✓	X	✓
30355	L2 export kWh	4	Float	kWh	01	62	✓	X	X
30357	L3 export kWh	4	Float	kWh	01	64	✓	X	X
30359	L1 total kWh	4	Float	kWh	01	66	✓	X	✓
30361	L2 total kWh	4	Float	kWh	01	68	✓	X	X
30363	L3 total kWh	4	Float	kWh	01	6A	✓	X	X
30365	L1 import kVarh	4	Float	kVarh	01	6C	✓	X	✓
30367	L2 import kVarh	4	Float	kVarh	01	6E	✓	X	X
30369	L3 import kVarh	4	Float	kVarh	01	70	✓	X	X
30371	L1 export kVarh	4	Float	kVarh	01	72	✓	X	✓
30373	L2 export kVarh	4	Float	kVarh	01	74	✓	X	X
30375	L3 export kVarh	4	Float	kVarh	01	76	✓	X	X
30377	L1 total kVarh	4	Float	kVarh	01	78	✓	X	✓
30379	L2 total kVarh	4	Float	kVarh	01	7A	✓	X	X

30381	L3 total kVArh	4	Float	kVArh	01	7C	√	X	X
-------	----------------	---	-------	-------	----	----	---	---	---

**Notes:**

1. The power factor has its sign adjusted to indicate the direction of the current. Positive refers to forward current, negative refers to reverse current.
2. The power sum demand calculation is for import – export.
3. Total kWh / kVArh equals to Import + export.

**5.2 Holding Register**

Function code	Description
10	Write parameter holding register
03	Read parameter holding register

Address Register	Parameter	Modbus Protocol Start Address Hex		Valid range	Mode (ro: read only wo: write only r/w: read/write)
		High Byte	Low Byte		
40001	Demand Time	00	00	Read minutes into first demand calculation. When the Demand Time reaches the Demand Period then the demand values are valid. Length: 4 bytes Data Format: Float	ro
40003	Demand Period	00	02	Demand Period time range: 0 to 60, 0 represents real-time update (demand updated every 1 second). Default: 60min Length : 4 bytes Data Format : Float	r/w
40011	System Type	00	0A	Write system type: 1 = 1P2W 2 = 3P3W 3 = 3P4W Default: 3P4W Length : 4 bytes Data Format : Float	r/w
40013	Pulse Output 1 Width	00	0C	Write pulse on period in milliseconds: 60, 100 ,200. Default: 200mS Length: 4 bytes Data Format: Float	r/w

40015	Key Parameter Programming Authorization (KPPA)	00	0E	Read: to get the status of the KPPA 0 = not authorized 1 = authorized Write the correct password to get KPPA, enable to program key parameters. Length: 4 bytes Data Format: Float	r/w
40019	Parity Stop	00	12	Write the network port parity/stop bits for MODBUS Protocol, where: 0 = One stop bit and no parity 1 = One stop bit and even parity 2 = One stop bit and odd parity 3 = Two stop bits and no parity Default: One stop bit and no parity Length: 4 bytes Data Format: Float	r/w
40021	Modbus Address	00	14	Address: 1 to 247 for MODBUS Protocol default : 1 Length : 4 bytes Data Format : Float	r/w
40023	Pulse 1 Rate	00	16	Write pulse rate index: n = 1 to 6 1 = 0.01kwh/imp 2 = 0.1kwh/imp 3 = 1kwh/imp 4 = 10kwh/imp 5 = 100kwh/imp 6 = 1000kwh/imp Default: 0.01kwh/imp Length : 4 bytes Data Format : Float	r/w
40025	Password	00	18	Set range 0000 ~ 9999 Default: 1000 Length: 4 bytes Data Format: Float	r/w
40029	Baud Rate	00	1C	Settable value: 0 = 2.4k bps 1 = 4.8k bps 2 = 9.6k bps 3 = 19.2k bps 4 = 38.4k bps Default: 9.6k bps Length: 4 bytes Data Format: Float	r/w
40047	PT ratio	00	2E	PT Ratio range:1~2000 Default: 1 Length : 4 bytes Data Format : Float	r/w

40049	PT2	00	30	PT 2 range: 100 ~500V Default: 400V Length : 4 bytes Data Format : Float	r/w
40051	CT 1	00	32	CT 1 range: CT2 = 5 CT 1 range:1~9999 CT2 = 1 CT 1 range:1~9999 Default: 5 Length : 4 bytes Data Format : Float	r/w
40053	CT2	00	34	CT 2: 1A or 5A Default: 5A Length: 4 bytes Data Format: Float	r/w
40061	Backlight time	00	3C	Backlight time : 0, 5, 10, 30, 60 ,120 min Default: 0 min Length: 4 bytes Data Format: Float	r/w
40087	Pulse 1 Energy Type	00	56	Write MODBUS Protocol input parameter for pulse out 1: 2 = total active energy 6 = total reactive energy Default: total reactive energy Length : 4 bytes Data Format : Float	r/w
461457	Reset	F0	10	00 00 = reset the Maximum demand Length : 2 bytes Data Format: Hex	wo
464513	Serial Number	FC	00	Serial number Length : 4 bytes Data Format : unsigned int32	ro
464515	Meter Code	FC	02	Read meter code Length : 2 bytes Data Format : hex	ro
464645	Software version	FC	84	Software version XX.YY XX = first byte YY = second byte Length : 2 bytes Data Format : Hex	ro
464647	Program Number	FC	86	Read program number Length : 2 bytes Data Format : Hex	ro

If you have any question, please feel free to contact our sales team.

**Eastron Electronic Co., Ltd.**

No. 52, Dongjin Road, Nanhu, Jiaying, Zhejiang, China

Tel: +86-573-83698881 Fax: +86-573-83698883

Email: sales@eastrongroup.com

www.eastrongroup.com

