

# SDM230-WIFI TY

Smart Single Phase Energy Meter



## USER MANUAL 2026 V1.1

## Statements

All rights reserved. Without the written permission of the company, no paragraphs or chapters in this manual can be extracted, copied or reproduced in any form. Otherwise, the violator shall bear all consequences.

Eastron reserves all legal rights.

Eastron reserves the right to amend the product specifications in this manual without prior notice. Before placing an order, please contact our company or local agent to get the latest specifications.

# CONTENT

Version History .....	1
Risk Information .....	2
Chapter 1. Introduction .....	4
1.1 Product Introduction .....	4
1.2 Product Characteristics .....	4
1.3 Application Scenarios .....	4
Chapter 2. Technical Parameters .....	5
2.1 Specifications .....	5
2.2 Product Features .....	7
2.3 Dimensions .....	8
2.4 Mounting .....	8
2.5 Wiring Diagram .....	9
Chapter 3. Operation .....	10
3.1 Installation Display .....	10
3.2 Button Functions .....	11
3.3 Measurements .....	11
3.4 Setup Mode .....	15
Chapter 4. Connecting to the "Smart Life" APP .....	18
4.1 Tuya .....	18
4.2 EASTRON Cloud .....	22

## Version History

Version	Date	Changes
1.0	2025-12-18	Initial issue
1.1	2026-3-19	Add the EASTRON Cloud Operating System

## Risk Information

### Information for Your Own Safety

This manual does not contain all of the safety measures operating the equipment (module, device) for different conditions and requirements. However, it does contain information which you must know for your own safety and to avoid damages. This information is highlighted by a warning triangle, which indicates the degree of potential danger.



#### Warning

This means that failure to observe the instruction can result in death, serious injury or considerable material damage.



#### Caution

This means hazard of electric shock and failure to take the necessary safety precautions will result in death, serious injury or considerable material damage.

### Qualified personnel

Operation of the equipment (module, device) described in this manual must only be performed by qualified personnel. Qualified personnel in this manual means people who are authorized to commission, start up, ground and label devices, systems and circuits in accordance with Safety Regulatory standards.

### Proper handling

The prerequisites for perfect, reliable operation of the product are proper transport, storage, installation and operation and maintenance. When operating electrical equipment, some parts of this equipment automatically carry dangerous voltages. Improper handling can therefore result in serious injuries or material damages.

- ✧ Use only insulating tools.
- ✧ Do not connect while circuit is live (hot).
- ✧ Place the meter only in dry surroundings.
- ✧ Do not mount the meter in an explosive area or expose the meter to dust, mildew and insects.
- ✧ Make sure the wires are suitable for the maximum current of this meter.
- ✧ Make sure the AC wires are connected correctly before activating the current/voltage to the meter.
- ✧ Do not touch the clamps directly with metal, blank wire or your bare hands as you may get electrical shock.
- ✧ Make sure the protection cover is placed after installation.
- ✧ Installation, maintenance and reparation should only be done by qualified personnel.
- ✧ Never break the seals or open the front cover as this might influence the function, and will void the warranty.
- ✧ Do not drop, or allow strong physical Hit on the meter as the high precisely components inside may be damaged.
- ✧ This product is designed to be mounted inside of switchboards or cabinet on DIN rail.
- ✧ This device must have a suitable sized Circuit Breaker feeding the Multi Function Energy Meter so it does not exceed the maximum rated current.

- ✧ The supply wiring of this device shall be suitable sized cable to match the installed circuit breaker.
- ✧ A Disconnection Device (Circuit Breaker) should be installed close to the Multi Function Energy Meter.
- ✧ The Disconnection Device shall be marked as the Disconnection Device for the Multi Function Energy Meter.

**Disclaimer**

We have checked the contents of this publication and every effort has been made to ensure that the descriptions are as accurate as possible.

However, deviations from the description cannot be completely ruled out, so that no liability can be accepted for any errors contained in the information given. The data in this manual is checked regularly and the necessary corrections are included in subsequent editions. We are grateful for any improvements that you suggest.

## Chapter 1. Introduction

### 1.1 Product Introduction

The SDM230-WIFI TY measures and displays the characteristics of single phase two wire (1p2w) supplies, including voltage, frequency, current, power, active energy, reactive energy, imported energy, exported energy and total harmonic distortion. Energy is measured in terms of kWh, kVAh. SDM230-WIFI TY supports max. 100A direct connection.

The SDM230-WIFI TY is equipped with a Wi-Fi communication function and supports communication with Tuya's "Smart Life" APP.

The SDM230-WIFI TY is configured with 2 channels of pulse output. The pulse constant, pulse width and pulse type are configurable. Parameter configuration can be implemented via the buttons on the panel. It is well functional with high security.

### 1.2 Product Characteristics

- Multi-parameter measurement
- Direct connection up to 100A
- Support communication with AMR and SCADA systems
- Bidirectional energy metering IMP & EXP
- Wi-Fi function supported
- Support communication with Tuya "Smart Life" APP
- Din rail mounting 35mm
- LCD with white backlit, adjustable backlit time

### 1.3 Application Scenarios

The SDM230-WIFI TY is a multi-functional power meter designed for power monitoring in power systems, public utilities, industrial applications, residential buildings and other scenarios. It is applicable to power transmission and distribution, AC charging piles, solar photovoltaic systems and other occasions. Its comprehensive communication function makes it highly suitable for various real-time power monitoring systems.

## Chapter 2. Technical Parameters

### 2.1 Specifications

Electrical Characteristics		
Type of Measurement	RMS	
Measurement Accuracy	Voltage	$\pm 0.2\%$
	Current	$\pm 0.2\%$
	Frequency	$\pm 0.05\%$
	Power Factor	$\pm 0.005$
	Active Power	$\pm 0.5\%$ (10%I <sub>b</sub> -I <sub>max</sub> )
	Reactive Power	$\pm 1\%$ (10%I <sub>b</sub> -I <sub>max</sub> )
	Apparent Power	$\pm 0.5\%$ (10%I <sub>b</sub> -I <sub>max</sub> )
	Active Energy	Class 0.5 IEC62053-21 Class C EN50470-3:2022
	Reactive Energy	Class 2 IEC 62053-23
Data Update Rate	1S	
	Voltage AC (U <sub>n</sub> )	230V AC
	Voltage Range	100-277V
	Frequency	50/60Hz
	Current Input	10A
	Maximum Current	100A
	Minimum Current	0.15A
	Starting Current (I <sub>st</sub> )	0.04A
	Transition Current (I <sub>tr</sub> )	1A
	Over Current Withstand	30I <sub>max</sub> for 0.01S
	AC Voltage Withstand	4KV/1min
	Impulse Voltage Withstand	6kV – 1.2/50 $\mu$ S waveform
	Voltage Circuit Power Consumption	$\leq 2W/10VA$
	Current Circuit Power Consumption	$\leq 0.05VA$
	Display	LCD with white backlit
	Max. reading	99999.99 kWh/kVAh
Mechanical Characteristics		
Net Weight	$\approx 160.5g$	
IP Degree of Protection (IEC 60529)	IP51 Front Display IP20 Whole Meter	
Dimensions (DxHxW)	100*72*66mm	
Mounting	DIN Rail 35mm	
Material of Meter Case	Self-extinguishing UL 94 V-0	
Mechanical Environment	M1	
Environmental Characteristics		

Operating Temperature	-40°C ~ +70°C
Storage Temperature	-40°C ~ +80°C
Operation humidity	≤90% Non-condensing
Storage humidity	≤95% Non-condensing
Pollution Degree	II
Altitude	≤2000m
Vibration	10Hz ~ 50Hz, IEC 60068-2-6
<b>Electromagnetic Compatibility</b>	
Electrostatic Discharge	IEC 61000-4-2
Immunity to Radiated Fields	IEC 61000-4-3
Immunity to Fast Transients	IEC 61000-4-4
Surge (Impulse) Immunity	IEC 61000-4-5
Conducted Immunity	IEC 61000-4-6
Immunity to Magnetic Fields	IEC 61000-4-8
Immunity to Voltage Dips	IEC 61000-4-11
Radiated Emissions	CISPR 32
Conducted Emissions	CISPR 32
<b>Safety</b>	
Measurement Category	Per IEC61010-1 CAT III
Installation Category	CAT III
Over-voltage Category	CAT III
Protective Class	II
<b>Interface</b>	
RF Band	2.412-2.484GHz
Max. RF Power	<17 dBm
Wi-Fi Protocol	802.11 b/g/n
Wi-Fi Range	Up to 30m / 100ft indoors and 50m / 160ft outdoors (Depends on local conditions)
<b>Pulse Output 1</b>	
Pulse Type	Import Active Energy, Total Active Energy, Export Active Energy, Import Reactive Energy, Total Reactive Energy, Export Reactive Energy(default).
Pulse Constant	0.01, 0.1, 1, 10, 100, 400 (default) Imp/kWh
Pulse Width	200, 100(default), 60mS
<b>Pulse Output 2</b>	
Pulse Type	Total Active Energy
Pulse Constant	400Imp/kWh
Pulse Width	100mS

## 2.2 Product Features

Note:

● = Available

— = Not Available

Features	Model
	SDM230-WIFI TY
<b>Instantaneous Measurements</b>	
Current	●
Voltage L-N	●
Frequency	●
Active Power	●
Reactive Power	●
Apparent Power	●
Power Factor	●
<b>Energy Values</b>	
Active Energy	●
Reactive Energy	●
Apparent Energy	●
<b>Demand</b>	
Current	●
Active Power	●
Reactive, Apparent Power	—
<b>Maximum Demand Values</b>	
Maximum Current	●
Maximum Active Power	●
Maximum Reactive, Apparent Power	—
<b>Power-Quality Values</b>	
Total Harmonic Distortion	—
Individual Harmonic Distortion	—
<b>Network</b>	
1 P 2 W	●
<b>Communications</b>	
Wi-Fi	●

### 技术标准:

[1] EN IEC61326-1: 2021 Electromagnetic Compatibility Directive - Electrical equipment for measurement, control and laboratory use - EMC requirements - Part 1: General requirements

[2] EN IEC 61326-2-3: 2021 Electromagnetic Compatibility Directive

[3] EN61010-1:2010+A1:2019 Low Voltage Directive 2014/35/EU - Safety requirements for electrical equipment for measurement, control, and laboratory use - Part 1: General requirements

[4] EN61010-2-030:2010 Low Voltage Directive 2014/35/EU - Particular requirements for testing and measuring circuits

[5] EN 50470-3:2022 Electricity metering equipment - Part 3: Particular requirements - Static meters for AC active energy (class indexes A, B and C)

## 2.3 Dimensions

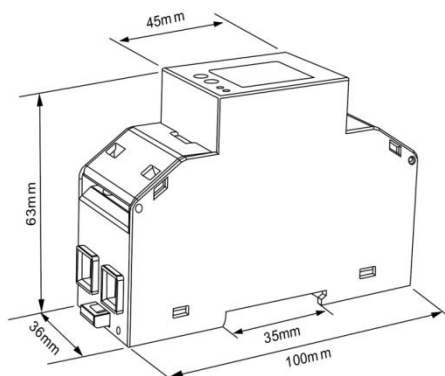

Height: 100 mm

Width: 36 mm

Depth: 63 mm

## 2.4 Mounting

Step 1: Select a 35mm-wide DIN rail, Pull down the back-end clip on the meter to unlock the mounting mechanism.

Step 2: Align Upper Slot with DIN Rail. Position the upper slot of the meter's DIN rail groove onto the DIN rail, ensuring full contact (see Figure 1).

Step 3: Following the direction indicated in Figure 1, engage the lower slot of the DIN rail groove onto the DIN rail until audibly seated (see Figure 2).

Step 4: Push up the back-end clip to lock the meter firmly onto the DIN rail (see Figure 3).

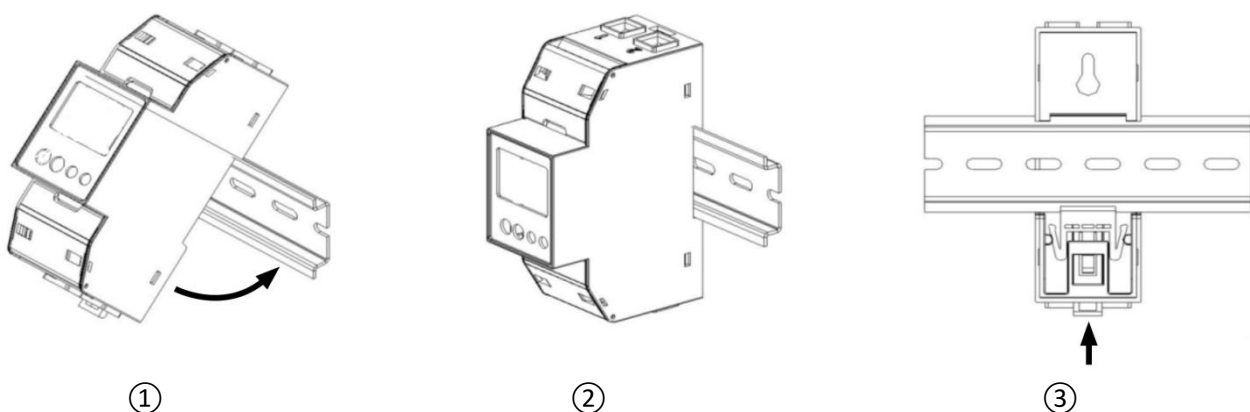

## 2.5 Wiring Diagram

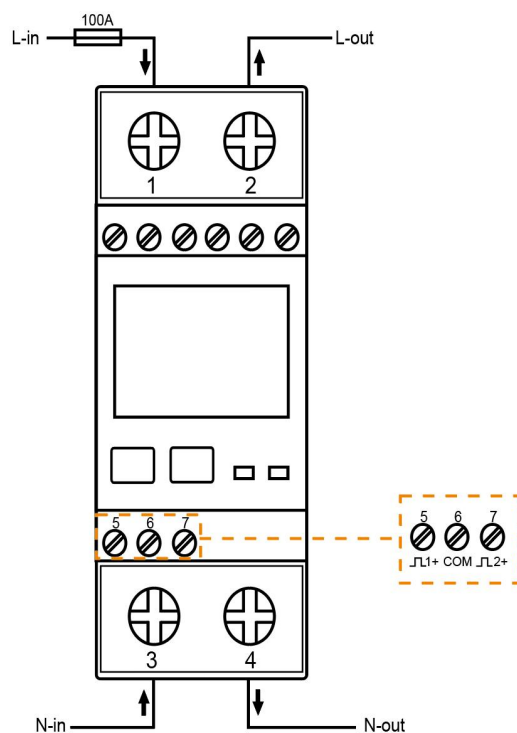





### Wiring Guide

Terminal ①~④	Measurement Connection	Screw Connection
	Strip Length	17-18mm
	Screw	M7
	Rigid/Supple	4-35mm <sup>2</sup> (11 ~ 2 AWG)
	Tightening Torque	3Nm
	Model	PH3
Terminal (B、A、B2、A2)	Measurement Connection	Screw Connection
	Strip Length	5-6mm
	Rigid/Supple	0.5-1.5mm <sup>2</sup> (22 ~ 14AWG)
	Tightening Torque	0.4Nm
	Model	PH0

## Chapter 3. Operation

### 3.1 Installation Display

Connect the wire and power on the meter to enter the normal measurement state. The screen display is as follows:



Page	Display	Description
1		The first screen lights up all display segments and can be used as a display check.
2		The second screen and the third screen indicate the firmware installed in the unit. Note: the actual display might be different with the left on here.
3		
4		The interface performs a self-test and indicates the result if the test passes.
5		Total Active Energy

### 3.2 Button Functions

There are 2 keys on the panel, and the key operations are divided into two types: long press and short press:



Long press: Press and hold the key for more than 3 seconds.







Short press: Release the key within 1 second after pressing.





Button	Short click		Long press (3s)	
	Display mode	Setup mode	Display mode	Setup mode
	Switch display screens	Next page or decrease value		Return to the previous menu
		Move to right side	Enter Setup mode	Confirm setting

### 3.3 Measurements

Below parameters can be checked by pressing of the  button:

Page	Display	Description
1		Total active energy in kWh
2		Imported active energy in kWh
3		Exported active energy in kWh

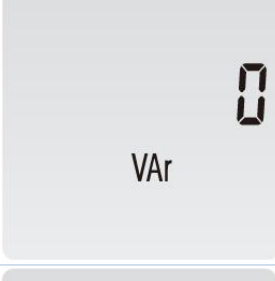
4		Total resettable energy in kWh
5		Total reactive energy in kVAh
6		Import reactive energy in kVAh
7		Export reactive energy in kVAh
8		Total resettable reactive energy in kVAh
9		Total Max. power demand

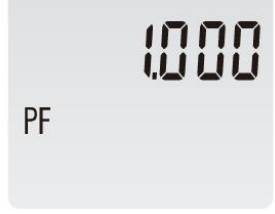





10	 A digital display showing the number 220.1 with a 'V' symbol below it.	Voltage
11	 A digital display showing the number 1000 with an 'A' symbol below it.	Current
12	 A digital display showing the number 0 with a 'W' symbol below it.	Active Power
13	 A digital display showing the number 0 with 'VAr' symbol to the left.	Reactive Power
14	 A digital display showing the number 0 with 'VA' symbol to the left.	Apparent power
15	 A digital display showing the number 1000 with 'PF' symbol to the left.	Power factor





16		Frequency
17		Running time
18-1		<p>Network Configuration State:          Network configuration was not completed, or the device has re-entered the pairing mode.</p>
18-2		<p>WiFi State:          Network Configured - Awaiting Internet Connection.</p>
18-3		<p>Upload Data State:          Internet connection successful. Device is now reporting data.          Note: The Wi - Fi icon in the upper-right corner of the screen indicates the current signal strength. It displays 1 to 6 bars; more bars represent a stronger Wi- Fi signal.</p>
19		WiFi Module Firmware Version Number.

### 3.4 Setup Mode

The meter's settable parameters have password protection. Long pressing on the  button to enter setup mode. Some menu items require a four-digit number entry while others, such as supply system, require selection from a number of menu options.

Setting Mode Key Operation Instructions:

1. Long press Key , enter the password, then long press again to access the setting interface.
2. Short press Key  to select the desired setting menu.
3. Long press Key  to enter the modification interface for that setting. Short press Key  to select the desired option, then long press Key  again to confirm.
4. Long press Key  to exit the setting interface.

Settings interface	Set status	Optional configuration
		<b>Password</b> Accessing the setting interface requires password entry. Default: 1000
		<b>Pulse Type</b> Option: EXPORT kWh, kWh, IMPORT kWh, EXPORT kVArh, kVArh, IMPORT kVArh. Default: kWh
		<b>Pulse Constant</b> Option: 1, 10, 100, 1000Imp/kWh Default: 1000Imp/kWh

		<p><b>Pulse Width</b>                  Option: 200, 100, 60mS                  Default: 100mS</p>
		<p><b>Demand interval time setting</b>                  Option: 0, 5, 10, 15, 20, 30, 60min                  Default: 60min</p>
		<p><b>Automatic Scroll Time Interval</b>                  Option: 0-255S                  Default: 0S (Does not automatically turn pages)</p>
		<p><b>Backlit time setting</b>                  Option: ON, 5, 10, 20, 30, 60, 120, OFF                  Default: 60</p>
		<p><b>CLR max demand setting</b></p>

		<p><b>Clear the resettable energy</b></p>
		<p><b>Password setting</b>                  Range: 0000~9999                  Default: 1000</p>
		<p><b>Enter NET SET Mode</b></p>
		<p><b>Exit NET SET Mode</b></p>

## Chapter 4. Connecting to the "Smart Life" APP

### 4.1 Tuya

#### 1. Initial State Description

The meter is not pre-configured with a Wi-Fi network during production.

After the first power-on, the meter automatically enters the network configuration mode. At this time, the Wi-Fi status interface of the meter is displayed as shown in Figure 1.



Figure 1

#### 2. Adding a Device

- Automatic Discovery:

Open the Tuya "Smart Life" APP. If the "Device to be added" pop-up window appears (as shown in Figure 2), click "Add".

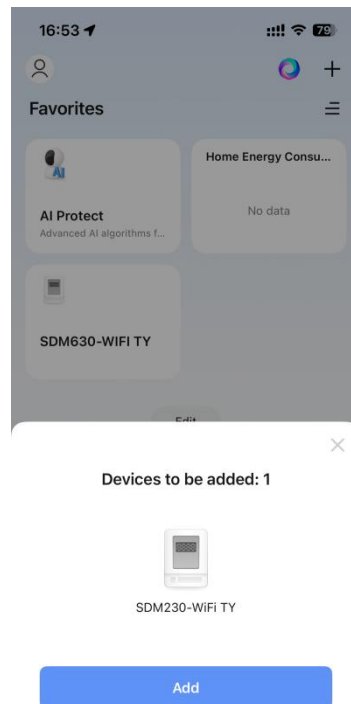

Figure 2

- Manual Addition:

If no prompt window pops up:

Click the "+" icon at the top right corner of the APP's homepage.

Select "Add Device".

Tap the corresponding meter icon to enter the manual addition process (as shown in Figure 3).

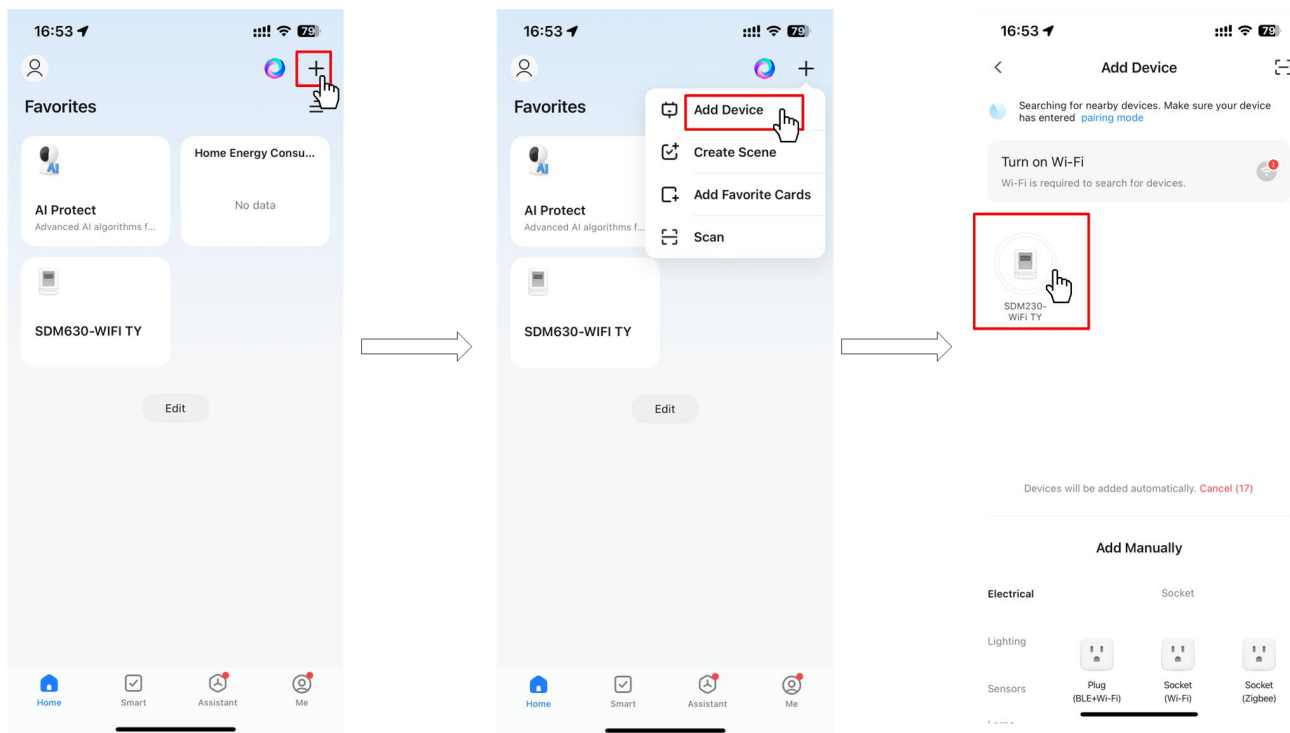

Figure 3

### 3. Wi-Fi Network Configuration

From the Wi-Fi list provided in the APP, select your network name.

Enter the password and confirm.

The meter will start connecting to the network (as shown in Figure 4) and enters the Wi-Fi connection state. Its Wi-Fi status interface is displayed as shown in Figure 5.

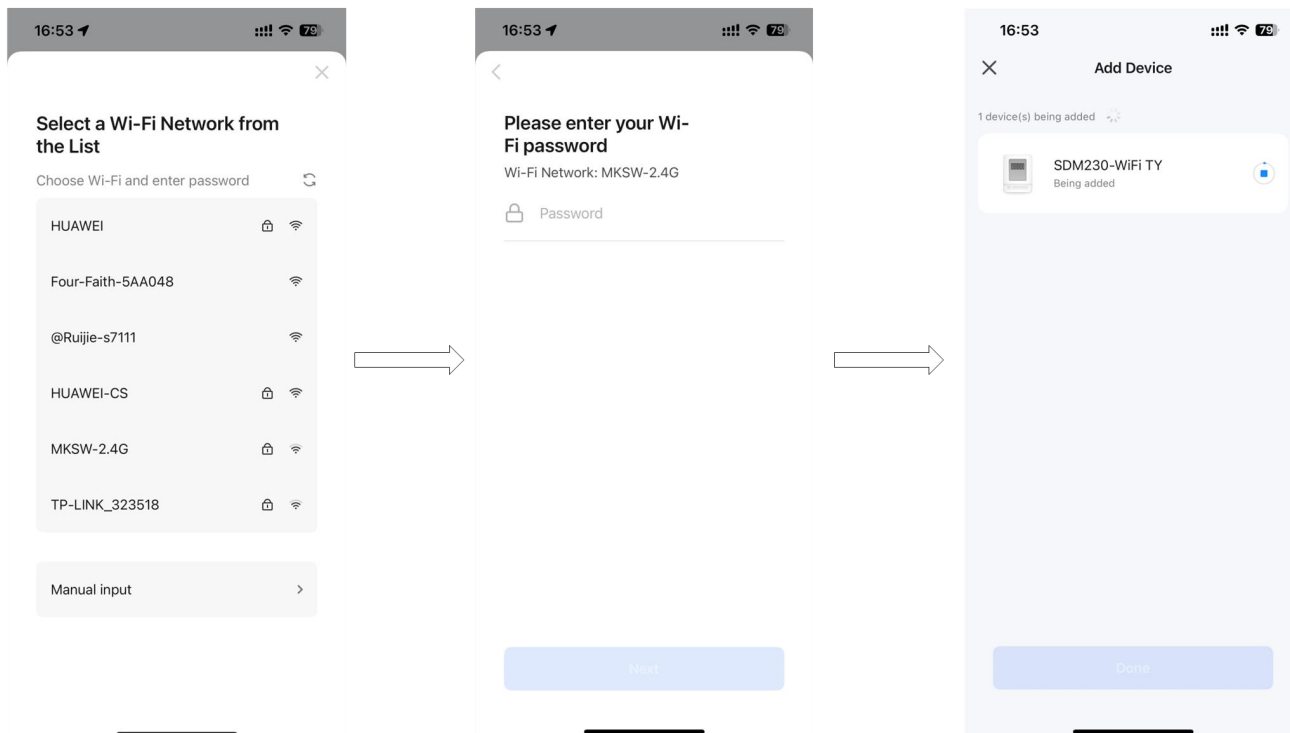

Figure 4



Figure 5

#### 4. Post-Connection Confirmation

After successful network connection, the meter enters the data reporting mode, and its Wi-Fi status interface is displayed as shown in Figure 6.

A "✔" icon will appear next to the corresponding device name in the APP, indicating successful connection.

Click "Finish" to access the APP's device details page, which will synchronously display the real-time parameters uploaded by the meter (as shown in Figure 7).

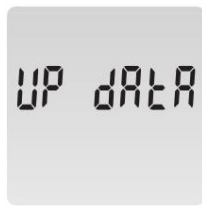

Figure 6

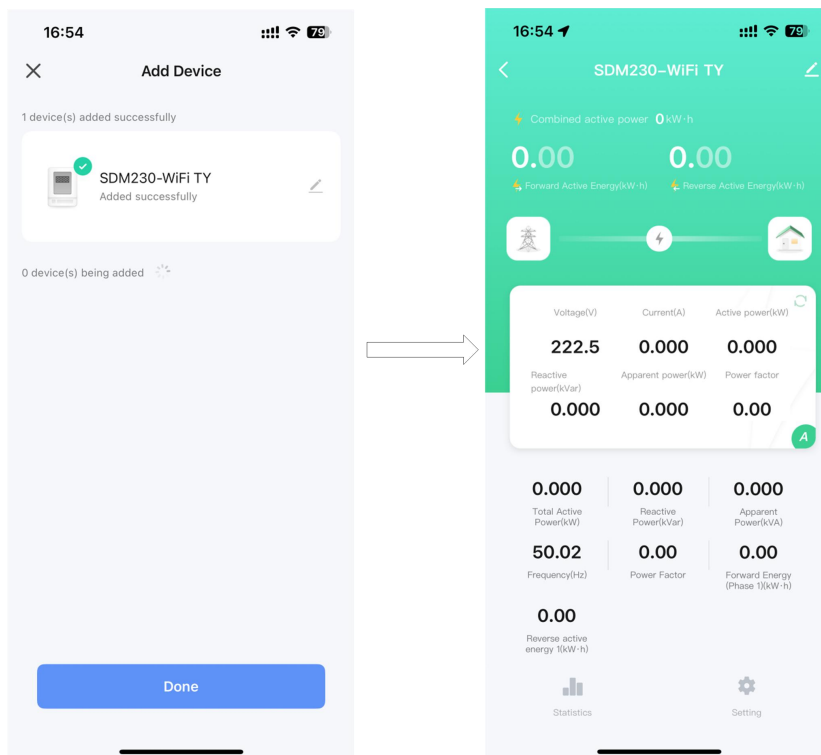

Figure 7

#### 5. Device Management

- Viewing Devices

The list of added devices is available on the APP's homepage. Click the corresponding device icon to enter the details page and view detailed parameters (as shown in Figure 8).

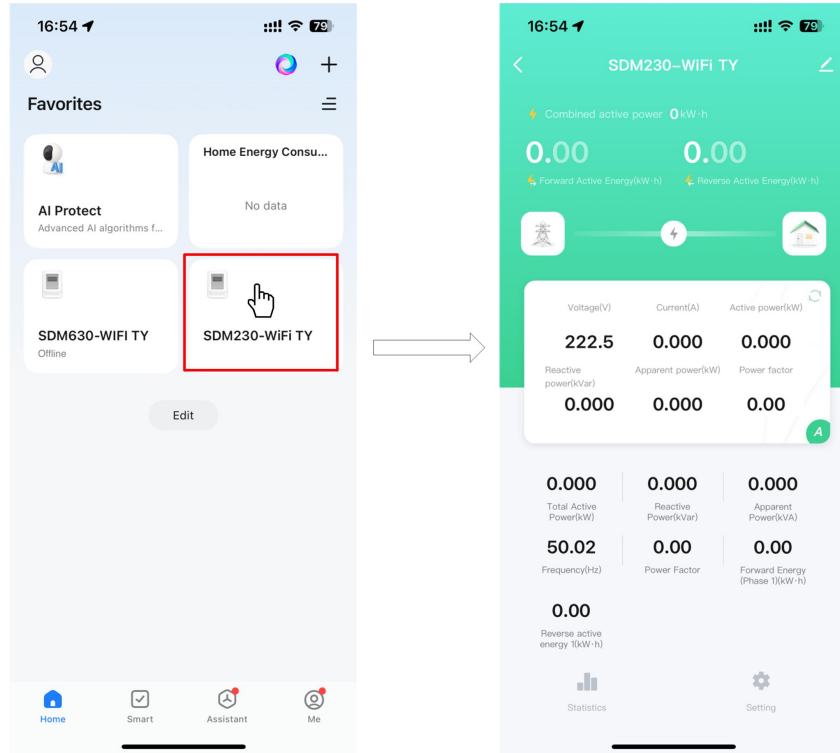

Figure 8

● **Deleting Devices:**

On the device details page, click the "Edit" icon at the top right corner.

Select "Remove Device" in the edit page to delete the current device from the APP (as shown in Figure 9).

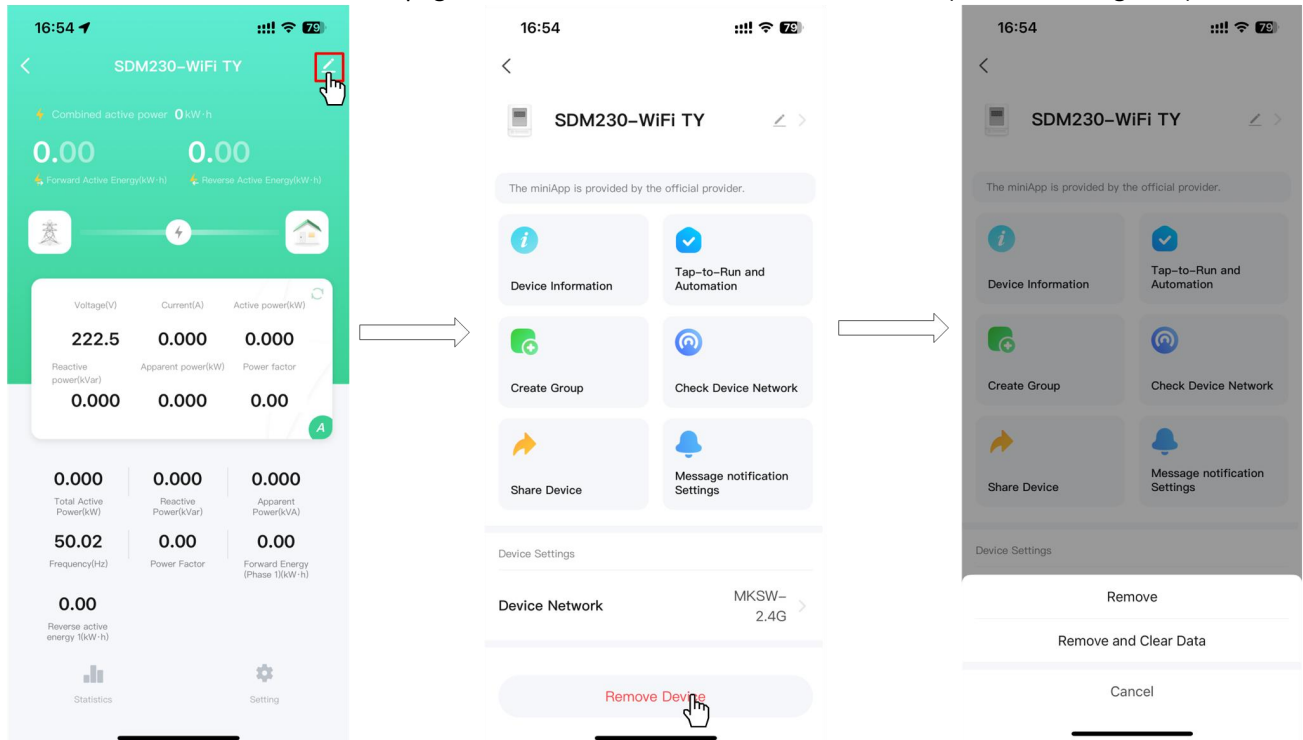

Figure 9

## 4.2 EASTRON Cloud

### 1. Initial State Description

The meter is not pre-configured with a Wi-Fi network during production.

After the first power-on, the meter automatically enters the network configuration mode. At this time, the Wi-Fi status interface of the meter is displayed as shown in Figure 1.



Figure 1

Note: If the meter has been previously connected to another device (such as a mobile phone), please unbind it first before rebinding.

### 2. Adding a Device

Tap "Add Device" on the APP page, or tap the "+" icon in the upper right corner of the home page.

Select "Add Device".

Tap the corresponding meter icon to enter the manual addition process (as shown in Figure 2).

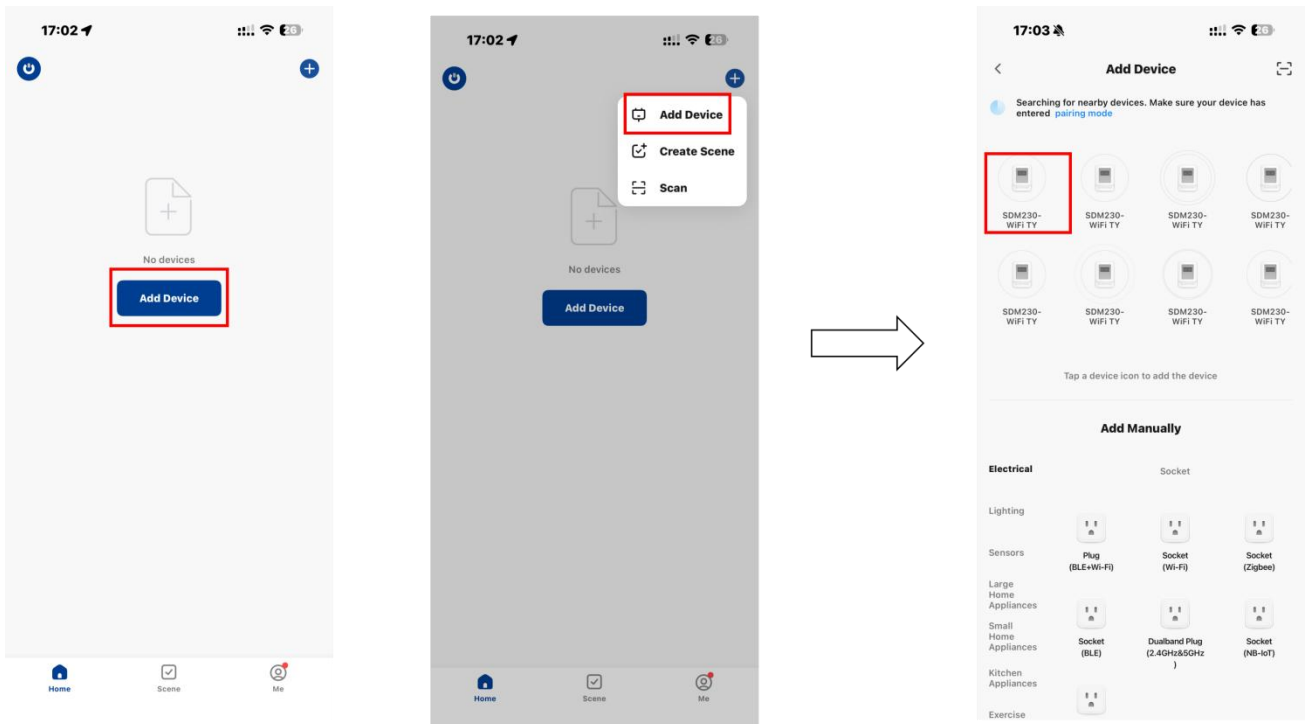

Figure 2

### 3. Wi-Fi Network Configuration

From the Wi-Fi list provided in the APP, select your network name.

Enter the password and confirm.

The meter will start connecting to the network (as shown in Figure 3) and enters the Wi-Fi connection state. Its Wi-Fi status interface is displayed as shown in Figure 4.

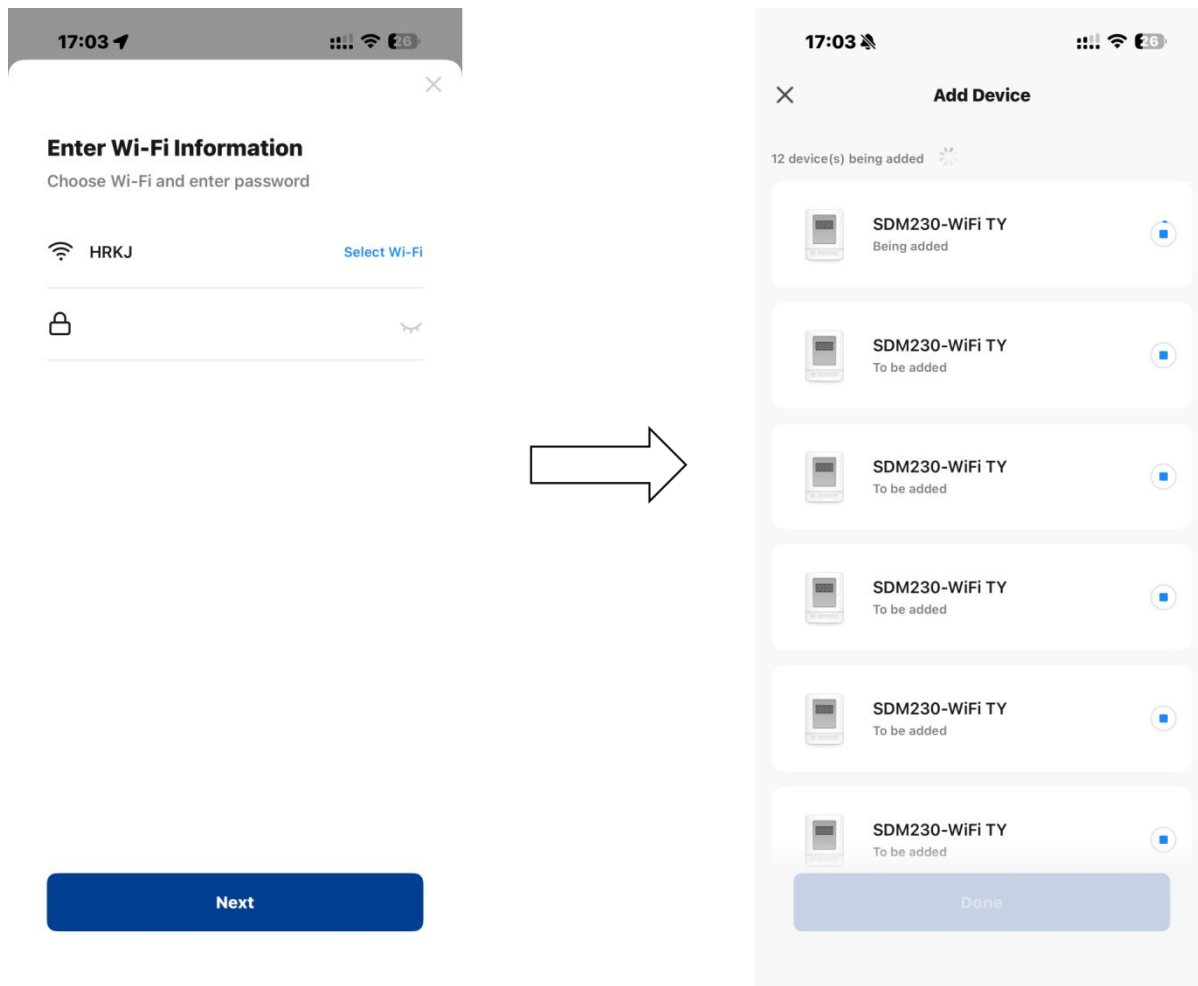

Figure 3

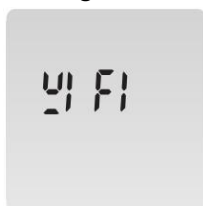

Figure 4

#### 4. Post-Connection Confirmation

After successful network connection, the meter enters the data reporting mode, and its Wi-Fi status interface is displayed as shown in Figure 5.

A "✔" icon will appear next to the corresponding device name in the APP, indicating successful connection.

Click "Finish" to access the APP's device details page, which will synchronously display the real-time parameters uploaded by the meter (as shown in Figure 6).



Figure 5

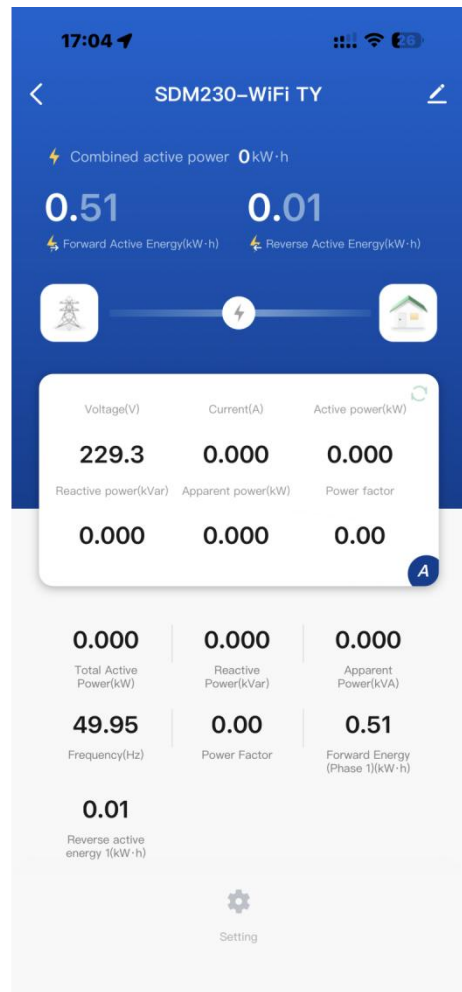
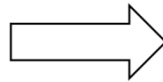
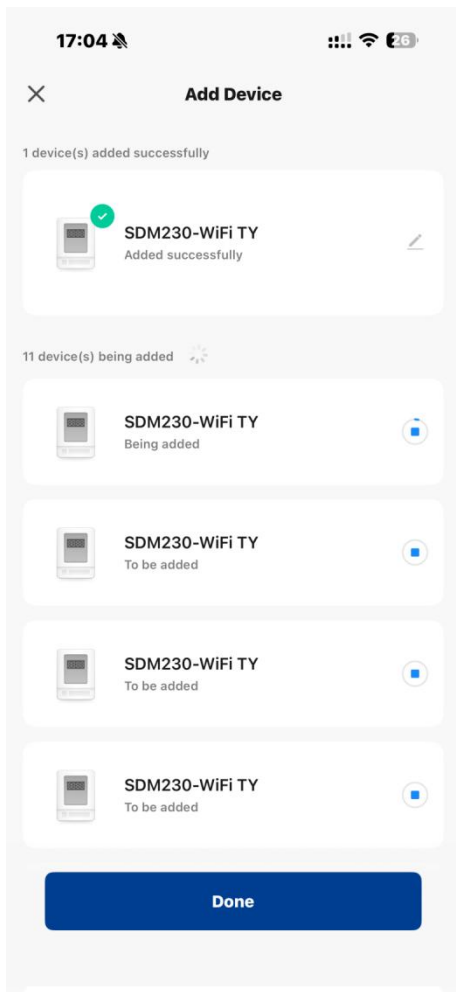

Figure 6

### 5. Device Management

- Viewing Devices

The list of added devices is available on the APP's homepage. Click the corresponding device icon to enter the details page and view detailed parameters (as shown in Figure 7).

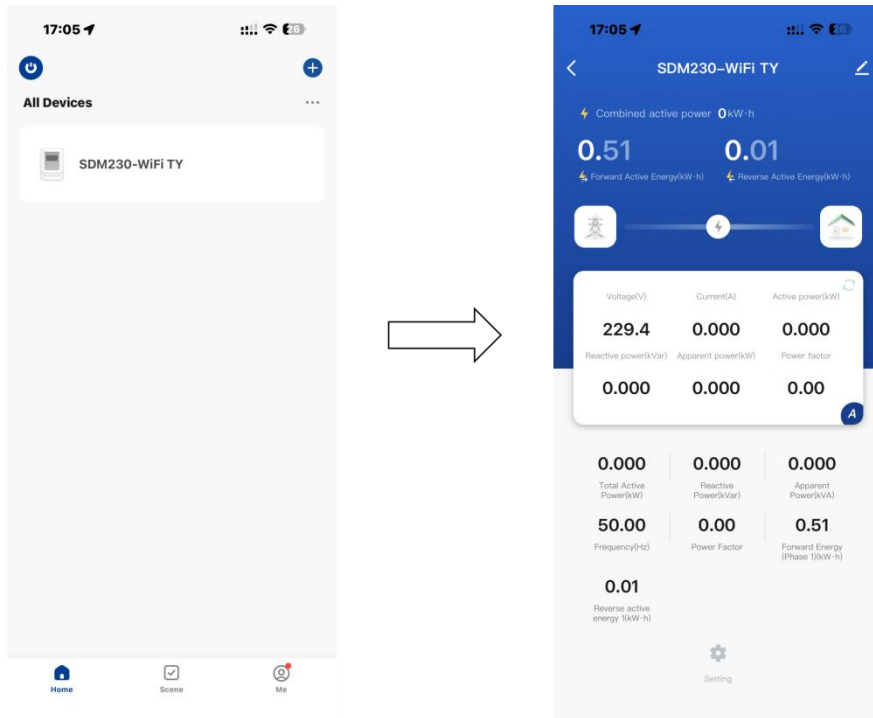

Figure 7

- Deleting Devices:

On the device details page, tap the “...” icon in the upper right corner, then tap “Device Management”, select the meter you want to remove, and you can remove the current device from the APP (as shown in Figure 8).

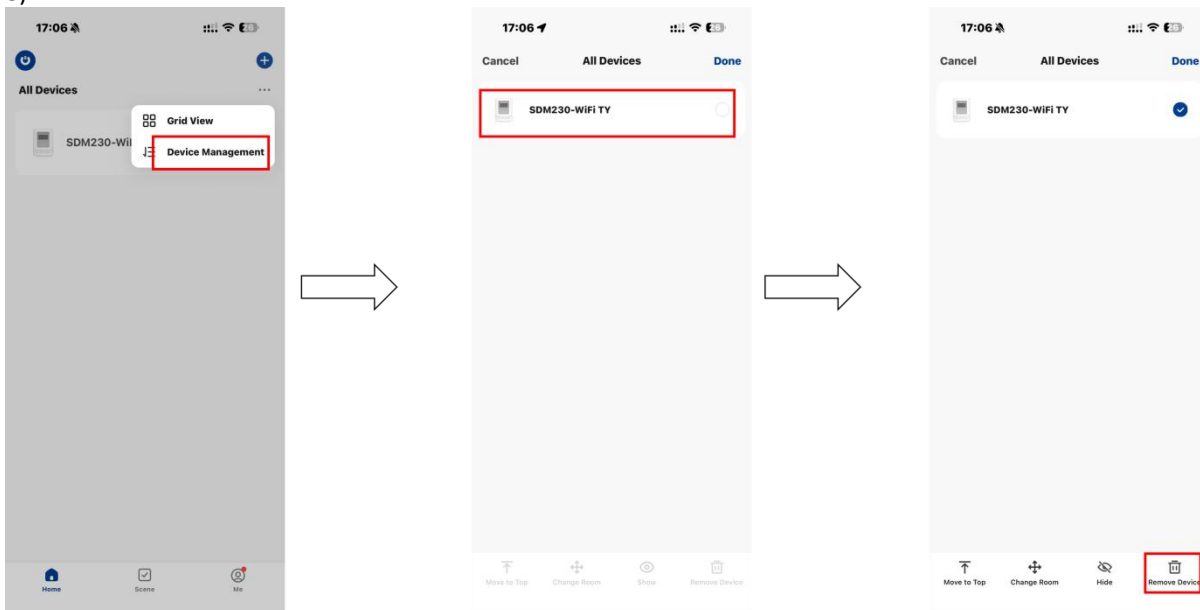

Figure 8

IF you have any question, please feel free to contact our sales team.

**Zhejiang Eastron Electronic Co., Ltd.**

No.52, DongJin Rd. Jiaxing, Zhejiang, 314001, China

Tel: 400-996-9296 Fax: +86-573-83698883

Email: sales@eastrongroup.com

[www.eastrongroup.com](http://www.eastrongroup.com)

